

SINGLE AXLE TIPPER



BRITAIN'S LEADING
TRAILER MANUFACTURER

In Safe Hands

SPECIALISTS IN TRAILER DESIGN & ENGINEERING

For 60 years people have put their trust in our trailers, just ask an owner they're not difficult to find. As specialists in trailer design and engineering, we have continued to set the standard both in the UK and throughout much of Europe.

We are an independent company with one focus: to build the best products on the market. More than 30,000 people choose our trailers each year - but we're not standing still. Our dedicated investment in new technologies and materials ensures that our products continue to exceed the expectations of our customers. We know that quality, strength, value and ease of maintenance are of vital importance to you. That's why we've made them the driving force behind everything we do.



Standard TT2012



TT2012 Single Axle Tipper

Introducing the much requested and highly versatile TT2012, Single Axle Tipper. This new and exciting product is the latest tipper in our TT range of Tipping Trailers.

The TT2012 is light, adaptable and has a wide range of applications. Weighing in at just under 400kg and with a GVW of 1500kg it bridges the gap between the unbraked range and our heavier duty tipping trailers. It is designed to make light work of carrying a 1 tonne payload of logs, gravel, rubble, garden debris, builder bag etc. Customers with lighter towing vehicles and small holders will be able to access a high-performance trailer. The trailer has been designed with a skip back making tipping easy. It also comes with a removable tailboard, that provides a closed back to ensure rubble and loose materials are retained during transit.

There are a number of accessories available on this highly versatile and innovative new trailer to suit many different users. These include a ladder-rack for carrying long awkward items, mesh sides and rear panel for bulkier items and a tarpaulin cover that provides convenient cargo restraint for loose items. The ladder rack and mesh sides are both interchangeable with the P6e trailer.



Features and Benefits

The TT2012 comes with various features and benefits as standard, in keeping with the ethos that is renowned by all Ifor Williams Trailers products, these include:

- Steel Welded and Galvanised Chassis
- A-Frame Drawbar Design
- Steel Welded and Galvanised Tipping Platform
- Steel Sides and Bed Construction
- Heavy Duty 3 Stage Hydraulic Ram
- Rugged 13" Tyres
- Renowned IWT Twin Leaf Parabolic Suspension
- Skip Back and Tail Board
- Body Latch for Security and Safety

Along with this list of excellent benefits, the trailer also comes with rope hooks, prop stands and a spare wheel fitted as standard.



Prop Stands

Provides additional stability when required.



Manual Pump

The manually operated hydraulic pump comes with a 6L rust proof tank for a long and reliable life.



Wheels & Tyres

The trailer is fitted with the rugged 185/70R13C tyres, with a spare wheel fitted as standard.



Rope Hooks

Fitted to the tipping body, rope hooks give extra security when used with rope or tarpaulin.



Skip Back & Tail Board

The trailer has been designed with a skip back making tipping easy. The tailboard provides a closed back to ensure rubble and loose materials are retained during transit.



TT2012 With Optional Mesh Side Kit

Optional Extras

The addition of selected accessories allows you to further enhance your trailer and tailor it to suit your specific needs, these include:

- Light Guards
- Tarpaulin Cover
- Ladder Rack
- Mesh Sides



Light Guards

Common with our other tipping trailers the road legal rear light guards offers protection when tipping, preventing the lights from being damaged.



Tarpaulin Cover

The tarpaulin cover is available to enhance the trailer and provides convenient cargo restraint for loose items.



Ladder Rack

For supporting long items such as timber, pipes, ladders etc.



Mesh Sides

Designed to offer versatility, the mesh side kit for the TT2012 is ideal for carrying loose items and bulkier material such as waste bags, branches, logs etc.



TT2012 With Optional Ladder Rack

Trailer Specifications

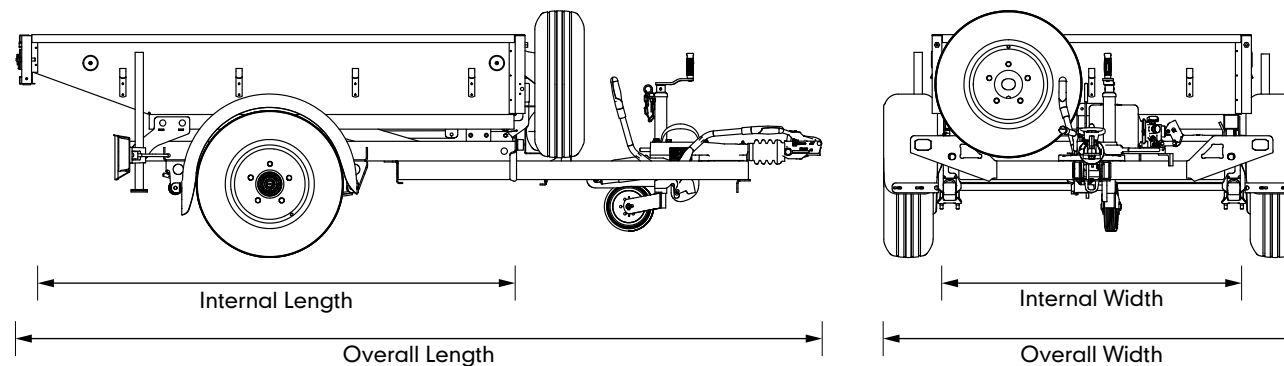

	Tyres	Maximum Gross Weight	Unladen Weight	Internal Length	Internal Width	Overall Length	Overall Width	Tipping Angle
TT2012	185/70R13C	1500kg	398kg	1975mm	1220mm	3270mm	1710mm	57°

Pricing

	Delivery Charge	Trailer	Mesh Side Kit	Ladder Rack Kit	Tarpaulin Cover	Light Guards
TT2012	£98	£2,790	£353	£59	£73	£40

Prices are Ex Works and are subject to delivery charges and the VAT Rate applicable at the date of supply



Ifor Williams Trailers Ltd
Cynwyd, Corwen,
Denbighshire LL21 0LB UK
Telephone +44 (0)1490 412527
sales@iwt.co.uk

For further information visit our comprehensive website
www.iwt.co.uk

Product design, descriptions, colours, specifications etc. correct at time of going to press. We constantly strive to improve our products, and from time to time this may result in changes to our range or to individual models. Please check that design, description, colours, specifications described in this brochure are still valid at the time of placing an order.

Our distributors have extensive product knowledge and will be pleased to offer assistance in the selection of your trailer.

No part of this publication may be reproduced in any form or by any means, without the prior written permission of Ifor Williams Trailers Ltd.

All Ifor Williams braked trailers come as standard with a 13 pin towing electric plug. This is in order to comply with the requirement under ECWVTA regulations to provide trailer reversing lights.

© Ifor Williams Trailers Ltd 2022. All rights reserved.