



Bellima

Round baler



Bellima 65

www.krone.de



Bellima

Success is so easy



- An enclosed baling chamber reduces fragmentation and controls the amount of dust
- An endless chain-and-slat elevator
 - excels in silage, hay and straw
 - eliminates the risk of the bale not rotating
 - produces high-density and well-shaped bales
 - achieves high bale weights
- Low input requirement
- Low dead weight
- Low in maintenance and long service life thanks to a simple design
- Few and short-length drive chains





Bellima:

This is the machine to depend on. Featuring an extremely robust fixed bale chamber, Bellima produces bales from silage, hay and straw of brick-like densities. At the same time, it is an absolutely low-maintenance machine that requires an extremely low input from the tractor.

Pick-up	4
Chain-and-slat elevator	8
Twin twine wrapping system	14
Net wrap system	16
Technical data	19

The pick-up

Nothing is left behind

- Clean pick up
- Accurate depth control
- Continuous crop flow
- Quieter running
- Rugged build



The pick-up for Bellima F 125

Our Bellima F 125 model features a 1,400 mm (4'7") pick-up (work width to DIN 11220) that is controlled hydraulically and locked at the desired depth. The small gap between the pick-up and the bale chamber optimizes the intake and flow of the crop.

A compact build for an efficient crop flow

The pick-up on the KRONE Bellima round baler stands out for its compact design. The small diameter rotor with four rows of tines together with the adjustable crop roller mounts close to the bale chamber and operates extremely efficiently, feeding even short and wet crop in a continuous flow into the chamber – a requirement for higher outputs and consistently shaped bales. The pick-up working height is adjusted by simply moving a pin. Ground contour following is controlled by height-adjustable gauge wheels.



1. Trouble-free functionality:

Bellima F 125 features an adjustable crop guard, which ensures a continuous flow of crop into the chamber, which is important when picking up large and uneven windrows.



2. Depth control:

This pin at the front conveniently sets the depth of the pick-up when no gauge wheels are used.

3. Nothing is left behind:

Four rows of tines spaced at 68 mm (2.7") give cleanest rakes and pick up even short stems.



4. Choice of metal or rubber wheels:

The gauge wheels adjust infinitely variably to the desired work depth to assure clean rakes. Pneumatic tyres give excellent and smooth running.



Pick-up with packer

Standard specification on Bellima F 130

- This pick-up works at a 1,800 mm (5'11") width – which is ideal for harvesting wide windrows
- The packer ensures a continuous flow of crop
- Feed augers on both ends optimize the crop flow into the machine
- Optional tyres on gauge wheels give superior and quiet running

i



The expert for wide windrows:

Baling in sloping fields, curves and corners often calls for a wider pick-up that is equipped with a crop feed system. The 1,800 mm (5'11") pick-up (DIN 11220) is the perfect equipment to achieve a high quality of work in these conditions.

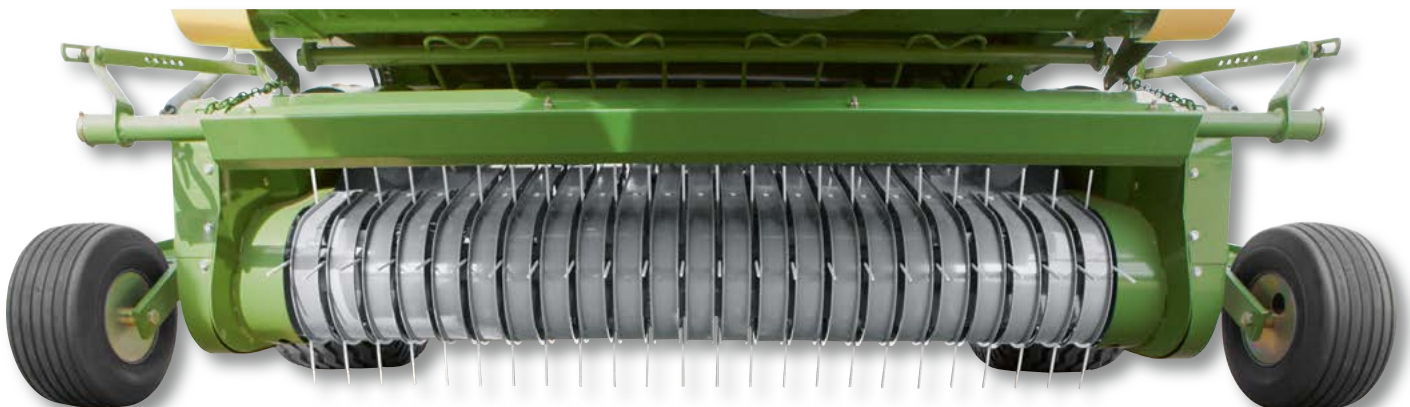

Take in more, put out more

The extra wide pick-up version with packer is standard specification on the Bellima F 130 model. Its packer works closely to the tines and the starter roller inside the baling chamber, providing a smooth and consistent flow even of short material into the machine. Boosting the machine's filling rate and capacity, the packer is a tremendous boost for the machine's overall efficiency and cost-effectiveness.

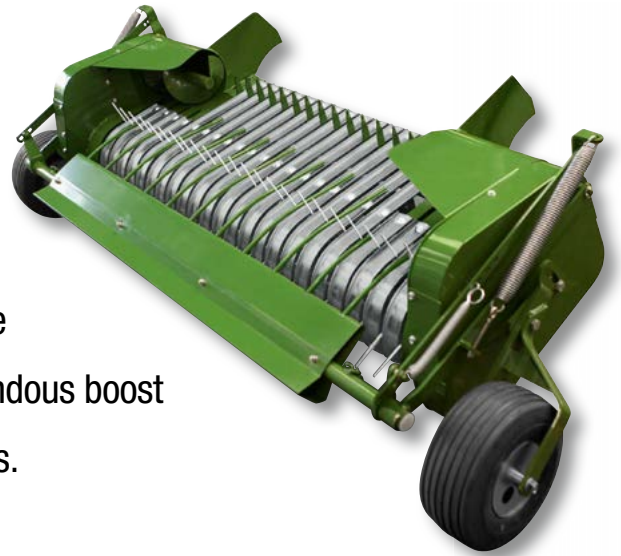

Active packer:

The packer actively transfers the crop from the pick-up to the starter roller, filling the baling chamber evenly and uniformly and making the pick-up more effective.



Clean rakes:

The pick-up depth is set on the gauge wheels, which allow stepless adjustment. For conditions like rutted and extremely uneven fields, the machine offers a pin and hole setting system on its front end.



Straightforward:

This chain sets the standard baffle plate to the desired position to enhance the flow of short crop into the machine.



Feed augers:

Massive augers feed the material from the sides to the middle, ensuring a smooth flow from the wide pick-up into the narrow bale chamber.

Chain-and-slat elevator

- Produces consistent 1.20 m (3'11") diameter bales
- Provides effective bale roll, eliminates bale stop, reduces loss due to fragmentation
- Requires a low tractor input
- Is simple by design with just one drive chain



A better spin on baling:

The enclosed bale chamber with endless chain-and-slat elevator forms the incoming material to high-density and firm bales – layer by layer. Providing an excellent bale feed, the elevator starts rolling the material at a very early stage so that the baling cycle finishes earlier as

well. At the same time, this elevator creates a firmer core for higher densities and weights as well as high-quality silage and in addition reduces bale handling effort and transport.

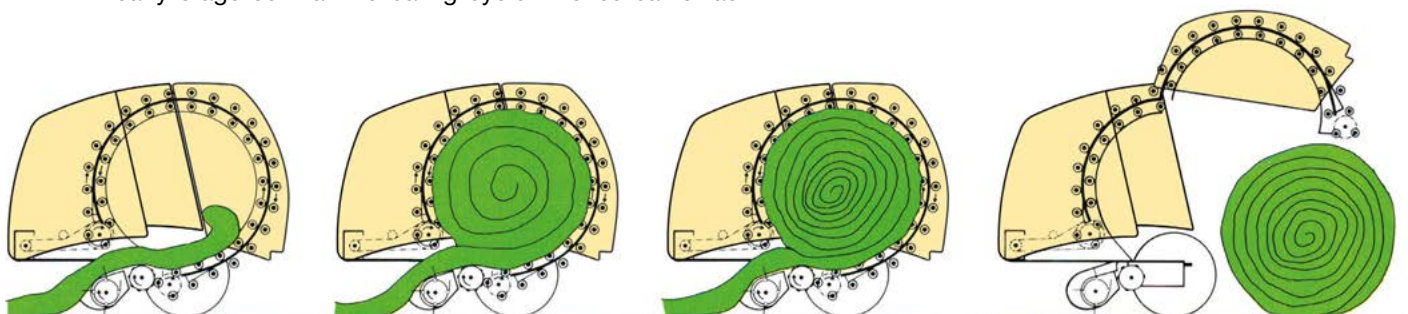

Well-proven around the world

This chain-and-slat elevator concept has proven extremely well in silage, hay and straw all over the world. The endless chain-and-slat elevator forms high-density bales and its 'meshing' design turns the bale without allowing it to stop – even when baling short and dry material. On top of that, the system reduces crop loss due to fragmentation and operates on a low tractor power input.



Straightforward and effective:

Open these panels and find an uncluttered interior – few drive chains and sprockets, and a simple and clear design that guarantees minimum maintenance and maximum longevity.

Robust and hard-wearing:

The chain-and-slat elevator has proven excellently in a wide variety of conditions. The round and solid slats and chains are on top of even the heaviest jobs.

The perfect solution:

The chain-and-slat elevator driveline uses only one single chain, a solution that reduces the required input power and boosts operational reliability.

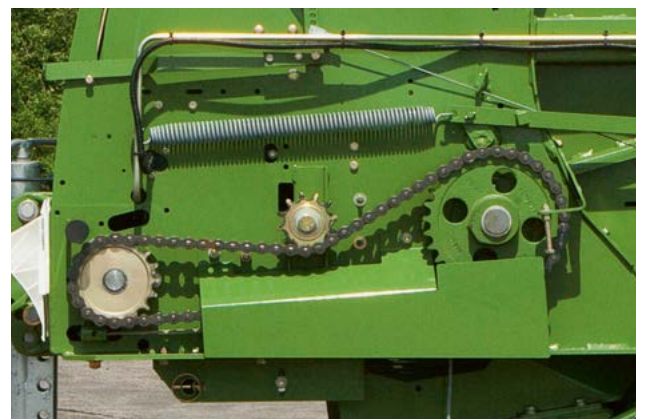



The KRONE chain-and-slat elevator

The system for straw, hay and silage

Round balers are harvesting straw, hay and wilted silage in a wide variety of conditions around the world. The challenge is high and well-known and calls for a machine that offers absolute operational reliability. Fragmentation is a risk in straw and hay where the crop was exposed to sustained drought, whereas wilted material may actually be wet and heavy after periods

of sustained rain. An added issue is in crops with high sugar content. The chain-and-slat elevator responds to all these multiple conditions and requirements and delivers absolutely dependable. This elevator never lets you down, giving a gentle but firm grip on the crop, 'meshing' with the bale and rolling it non-stop while keeping the pressure high.



Operating in silage



... hay...

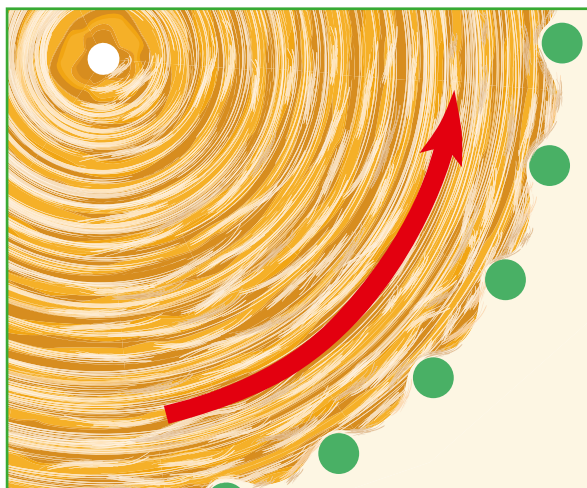

... and straw

Bellima – the art of refinement

Buying a Bellima means tapping into KRONE's vast experience and expertise gained in decades of baler manufacturing. We at KRONE understand farmers' needs. Our round balers operate around the world and have proven excellently in a wide variety of conditions. In addition to providing high bale densities, KRONE balers are extremely robust, simple by design and perfect in specification. Last but not least, they offer superior operational reliability.



Positive bale starts:

The profiled starter roller takes care of an instant bale start, optimizes the entire process and takes load off the rear door, which is ideal when baling heavy silage bales.



Pressure indicators on either side:

Baling pressure indicators on either side of the machine show the current loading inside the chamber so the operator can correct his steering and ensure the chamber is filled uniformly – for uniform bale densities and shapes.



Little helpers:

An audible / LED alarm is available as an option to indicate acoustically and visually when the baling pressure is right so the operator can trigger the twine wrapping cycle.



Automatic chain tensioning:

The tensioning system on the chain-and-slat elevator operates automatically and uses springs to maintain the tension, enhancing the chain's longevity and functionality and giving operators peace of mind.



Powerful driveline:

The main gearbox (540 rpm) is located in the center and splits the incoming power to either side, cutting down on driveline length and optimizing the power flow to the pick-up and the chain-and-slat elevator.



Secure locking:

Two single-acting rams on either side of the machine open and close the rear door hydraulically. The door is locked mechanically, which reduces the load on the hydraulic system and gives peace of mind.



More bales per hour:

The optional KRONE Mini-Stop tray serves as bale ejector and collecting tray! It allows the baler to start the next baling cycle while the rear door is still closing after the bale was ejected. The small detail increases your output by up to six bales per hour!

Twin twine wrapping system

Works twice as fast

- Two twines cut down on the time of the wrapping cycle
- Well-shaped bales because tying starts / ends in the middle of the bale
- Select the twine spacing
- Easy-to-use system



Simple by design – dependable in the field:

A coned pulley controls the number of twine wraps applied per cycle. Two pieces of twine run through drivers from the center to either side and back to the center of the chamber, where they are cut at the end of the tying cycle. Tying is triggered hydraulically, electrically or mechanically.



Twin wrapped for best shape

A twin twine tying system cuts down on machine downtime, increases output per hour, saves on fuel and labor cost and increases your output. The KRONE twin twine tying system places the twine ends in the middle of the bale and not on the edges. This is an important detail that ensures the bale stays in good shape even after multiple handling and transfer operations.

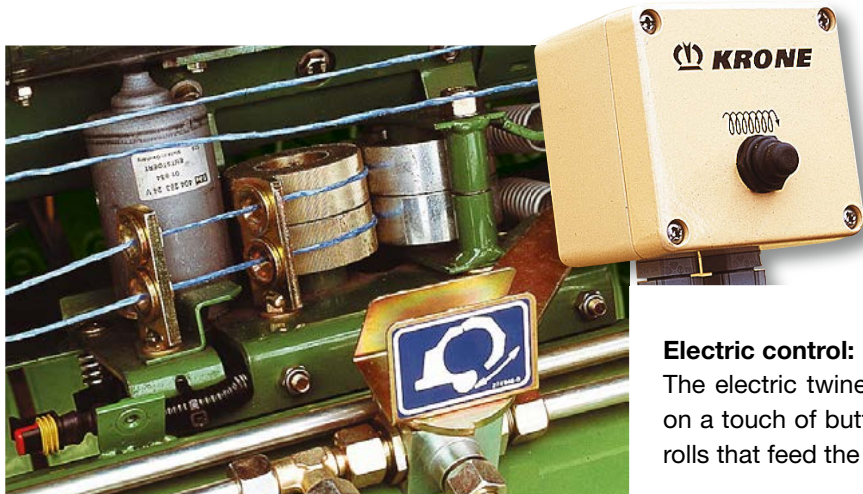

Electric control:

The electric twine starter triggers twin twine wrapping on a touch of button. The system also starts the guide rolls that feed the threads to bale chamber.



Hydraulic control:

The hydraulic twine starter is a convenient version, which allows starting the twine wrapping system and the twine/net wrapping system from the tractor cab.



Plenty of storage space:

The twine box stores up to six balls and makes for quick and easy replacement. The balls are fixed in position by a bracket.



Net wrapping

Perfect wraps for perfect bales

- Short cycles - produce more bales per hour
- Positive wrap start – short feed system
- Bales break up quickly and easily for feeding



Perfect:

The net wrap assembly is at the front end, where it is in excellent operator view and holds 2,600 m or 3,600 m (8,530' or 11,811') net rolls. There is room for one spare roll.

Easy fitting:

Twine or net replacement is convenient and safe, because the operator can stand upright when reloading. He simply swings out the dispenser arm and slides the fresh roll onto it. Then he feeds the net into the net wrap system. Done.



Less fuel per bale

The net wrap system is simple by design and offers superior functionality. A net wrapping cycle is shorter than a twine wrapping cycle so that the machine is able to put out more bales per hour. Higher throughputs free up time for other jobs and cut the tractor's consumption per bale. The net wrap system accepts KRONE excellent rolls with total net lengths of up to 3,600 m (11,811').



Hydraulic control:

Net and twine wrapping is triggered from the cab based spool.



Tensioned:

The adjustable net brake ensures the bale is wrapped across its full width to achieve an exemplary bale shape. The bales will not come apart even when transferred multiple times.



Controlling the net feed:

The threaded shaft sets the number of wraps. The current length of the thread controls the time the rail with spring contacts the thread. The net is cut when the rail swings down.

Full-width wrapping:

The net (1) is fed across the full width of the bale chamber to the rubber drive roller (2) and the pressure roller (3). As the wrapping cycle is triggered, the rubber roller feeds the net to the rotating bale.

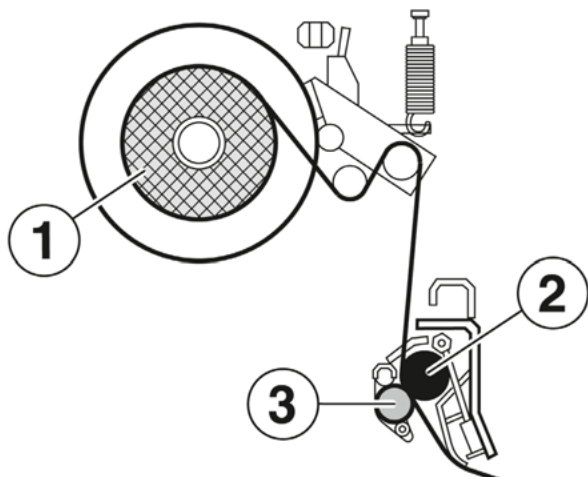



The perfect match:

The drawbar height is set easily and fast by a notching system. The drawbar turns to suit pin-hitch and regular drawbar attachments.

Straightforward:

The single-acting coupler is standard specification on Bellima. The reversing valve operates the pick-up or the rear door.

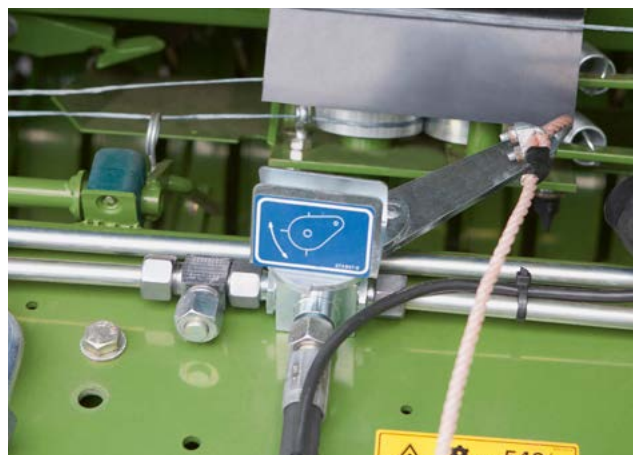
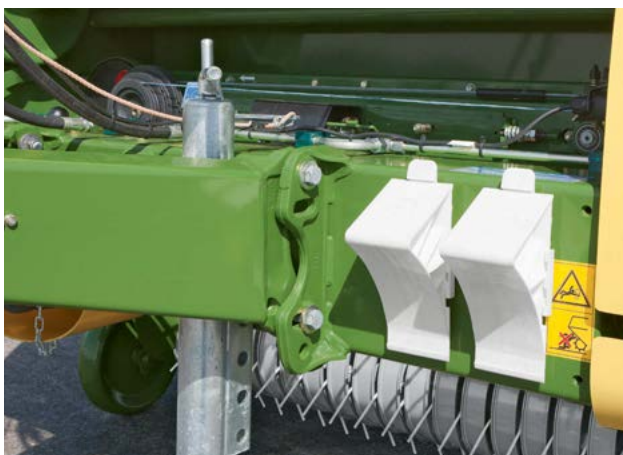

Technical Data

Bellima round baler

		Bellima F 125	Bellima F 130
Bale diameter	Approx. m	1.2 (3'11")	1.2 (3'11")
Bale width	Approx. m	1.2 (3'11")	1.2 (3'11")
Length	Approx. mm	3,700 (12'2")	3,700 (12'2")
Width	Approx. mm	2,250 (7'5")	2,250 (7'5")
Height	Approx. mm	1,970 (6'5.6")	1,980 (6'6")
Pick-up work width (to DIN 11220)	Approx. mm	1,400 (4'7")	1,800 (5'11")
Track width	Approx. mm	1,900 (6'3")	1,950 (6'5")
Standard tyres		10.0/75-15.3 8 PR 11.5/80-15.3 10 PR	11.5/80-15.3 10 PR 15.0/55-17 10 PR 19.0/45-17 10 PR
Weight	Approx. kg/lbs	1,570 (3,461.22)	1,730 (3,813.96)
Power requirement	kW / hp	25/34	25/34
Hydraulic couplers		1 sa	1 sa

All specifications, weights and dimensions do not necessarily comply with standard specifications and are therefore not binding.



KRONE excellent net wrap:

All KRONE excellent net wrap products provide excellent spread from edge to edge in all harvest conditions. excellent Edge and the extremely tear-resistant StrongEdge cover the

bale exactly from edge to edge while excellent RoundEdge cover the bale beyond its edges for optimum protection from moisture and exposure to weather.

KRONE Internet

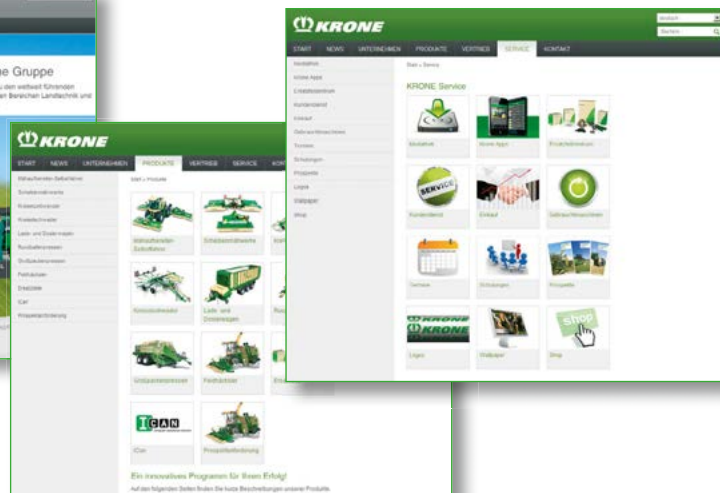
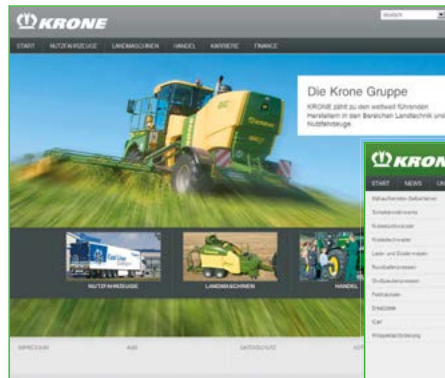

Discover the world at KRONE and browse through our website pages to find facts and figures and also new developments plus a wide range of services. Explore our website and find out how versatile the KRONE world is.



News

Click here to find up-to-the minute information about KRONE – from new product presentations to show reviews. Here you are at the pulse of KRONE life.



Products

Find extensive information on our full product range. This section holds everything you need – from video clips to manuals.



Sales organisation

Here you find a distributor in Japan as well as your local KRONE dealer who will be pleased to support you. This is where you find your KRONE partner who will be pleased to assist you.



Jobs

Would you like to join our company? KRONE is often looking for diligent and motivated staff to work at our farm machinery factory as well as at our commercial trailer production plant. So, this section is always worth a visit.



Media center

The KRONE 'database' holds thousands of documents, pictures, test reports and much more. Here you find very detailed information on KRONE products that are of special interest to you.



Events

Are you in for a KRONE live experience? Check out for KRONE events and look at a machine on show or watch it during a demonstration. After all, there is little that is more effective than a hands-on experience.



Service

Here you find all the service information you require – from a point of contact at the factory to finance schemes for your KRONE machine as well as training schemes for staff and users.



Download Center

Are you looking for a KRONE calendar for your desktop or a smart picture for your presentation? Here, at the KRONE download center, you will find plenty of useful material for a wide range of projects.



Used Machinery

KRONE often has a wide range of demonstration or exhibit machinery on offer. This is a good site to find your KRONE machine. Then contact your local KRONE dealer to arrange the details of a potential purchase.



Parts

24/7... This service gives you the opportunity to find your KRONE part at any time and without waiting. The KRONE Agroparts Portal has an article number and exact description for every part. You can order the part instantly at your local KRONE dealer by sending an e-mail to Agroparts.



KRONE shop

Are you looking for a gift or are you a collector of farm models? Then you should definitely shop around at our KRONE shop. We take your orders at any time of the day.

Your KRONE dealer

Maschinenfabrik Bernard KRONE GmbH

Heinrich-Krone-Straße 10
D-48480 Spelle

Telefon: +49 (0) 5977.935-0
Telefax: +49 (0) 5977.935-339

info.ldm@krone.de
www.krone.de